

SOLENOID VALVES

GEM-A3P | Latch 3 positioning manual override
2 Way, 3 Way NC, NO

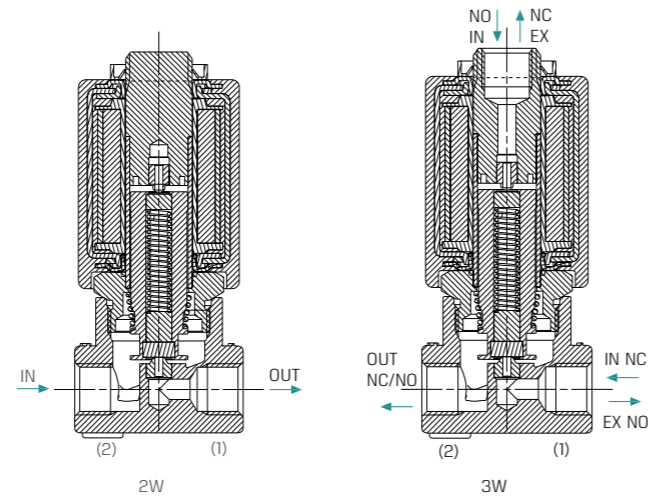

Technical Data

Function	2/2, 3 Way NC, NO
Ports size	1/8" and 1/4" BSP & NPT
Orifice size	See table
Pressure range	See table
Kv (l/min)	See table
Temperature range	Fluid : -10°C to 80°C (no freezing) Ambient : -10°C to 50°C
Materials in contact with media	Manual override: Plastic Main Valve: Brass Solenoid Operator: Stainless Steel AISI 300 & 400 series Seals: NBR, FKM, EPDM, FFKM or PTFE
Media	Air, water, oil
Coil type	Latch
Standard protection class	IP65 with connector * Option : IP68 (please refer to GEM-BP Coil)

Max. Pressure (bar) 2W NC table

Orifice (mm)	0.8	1.2	1.6	2.0	2.4	3.0	4.0
Pressure (bar)	16	16	16	16	16	16	8
Flow factor Kv(l/min)	0.5	1.1	1.7	2.5	3.5	4.5	5

Max. Pressure (bar) 2W NO table

Orifice (mm)	0.8	1.2	1.6	2.0	2.4	3.0
Pressure (bar)	16	16	16	16	15	10
Flow factor Kv(l/min)	0.5	1.1	1.7	2.5	3.5	4.5

Max. Pressure (bar) 3W NC table

Orifice (mm)	0.8	1.2	1.6	2.0	2.4	3.0
Pressure (bar)	16	16	16	14	10	6
Flow factor Kv(l/min)	0.5	1.1	1.7	2.5	3.5	4.5

Max. Pressure (bar) 3W NO table

Orifice (mm)	0.8	1.2	1.6	2.0	2.4	3.0
Pressure (bar)	16	16	16	12	10	7
Flow factor Kv(l/min)	0.5	1.1	1.7	2.5	3.5	4.5

GEM-A3P | Latch 3 positioning manual override
2 Way, 3 Way NC, NO

Dimensions

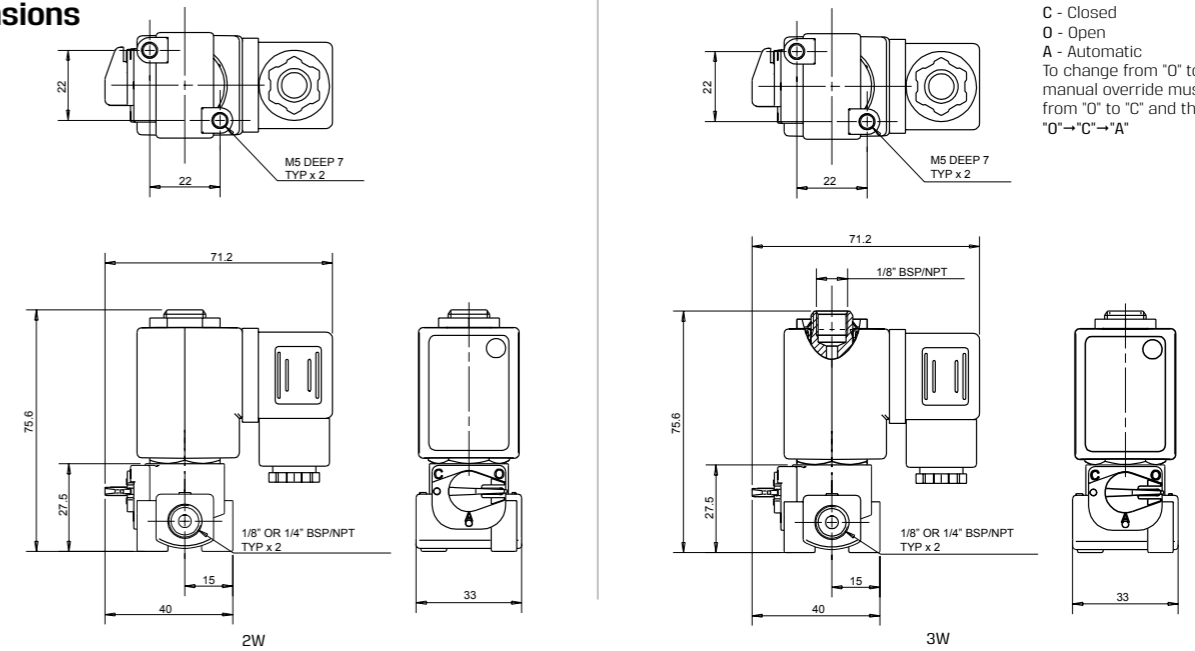

Note :
C - Closed
O - Open
A - Automatic
To change from "O" to "A", the manual override must be turned from "O" to "C" and then to "A" : "O"→"C"→"A"

How to Order

GEM-A3P	BODY	PORT	FUNCTION	ORIFICE	SEALS	LATCH TYPE ⁽¹⁾	CONNECTOR						
Brass	2	1/8" BSP	10	2W NC	1	0.8	1	NBR	N	2Ω	LDO	without	0
		1/8" NPT	11	2W NO	2	1.2	2	FKM	V	5Ω	IL	with	1
		1/4" BSP	20	3W NC	3	1.6	3	EPDM	E	13Ω	EL	flying leads coil	4
		1/4" NPT	21	3W NO	4	2.0	4	FFKM	K	20Ω	OL	with 1/2" Hub	5
						2.4	5	PTFE	T	53Ω	DL	connector with moulded cable	7
						3.0	6					other	9
						4.0	7						

Example : GEM-A3P-21015N-LD01

GEM-SOL latch 3 positioning manual override, brass, 1/8"BSP, 2W NC, 2.4 orifice, NBR, 2Ω latch with connector

GEM-A3P - 2 10 1 5 N - LDO 1

(1) Choose latch type according to which latch system you have

* To order valves manufactured according to your specific requirements, please contact our technical sales department